



FULL MANUAL

<https://www.bft-automation.com/qrcodemanual/D814283>

# THALIA BT A80/A160



D814375 0ADAO\_05 22-03-24

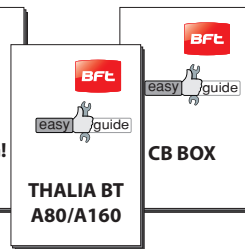
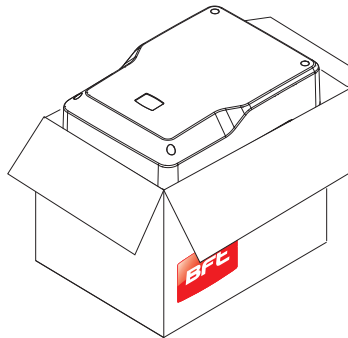

**DUO**

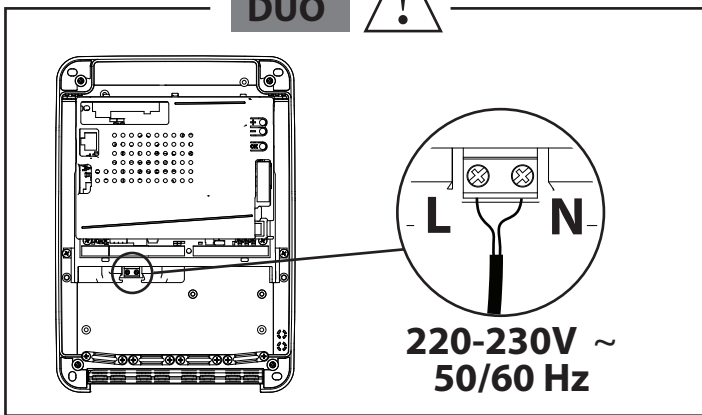

220-230V ~  
50/60 Hz

**FLAT**

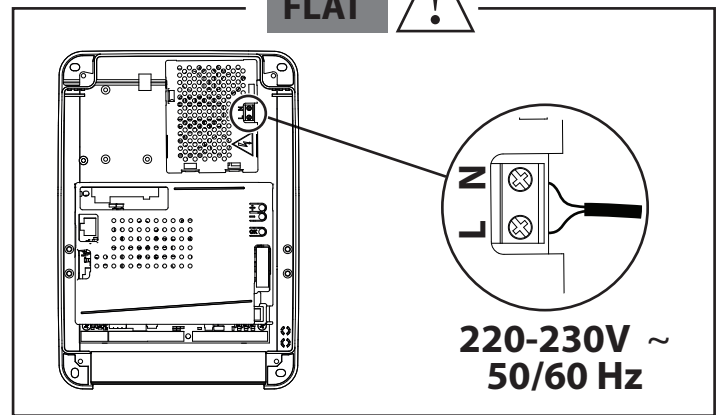

220-230V ~  
50/60 Hz

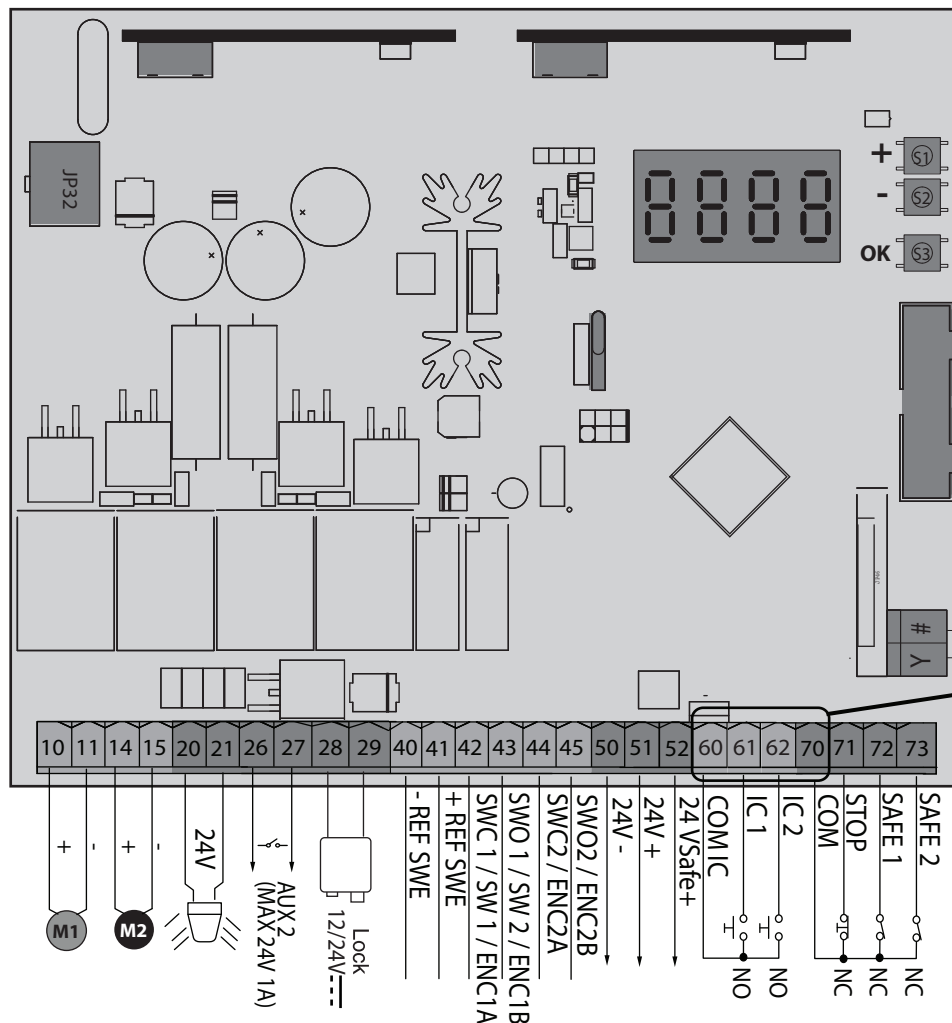

	THALIA BT A80	THALIA BT A160
	220-230 V 50/60 Hz	
<b>P stand-by</b>	0,4 W	
<b>Pmax</b>	200 W	400 W
	433,92 MHz	
<b>IP</b>	DUO	DUO
	45	45
	-20°C / +60°C	-20°C / +55°C

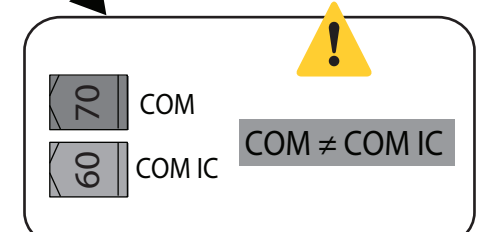
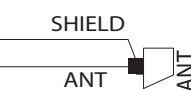

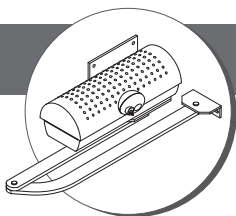

**IGEA BT**

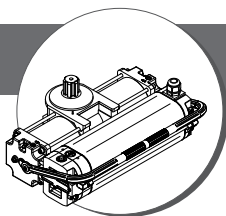
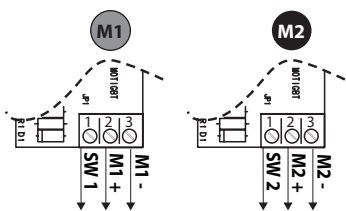
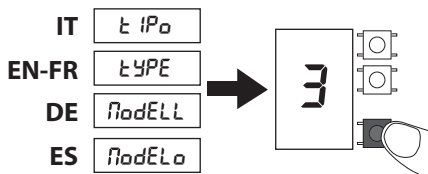

**SUB BT**

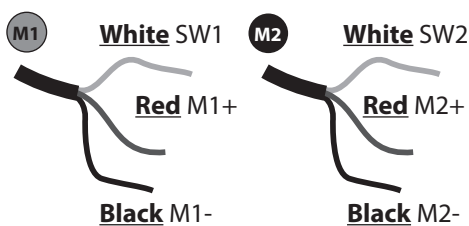
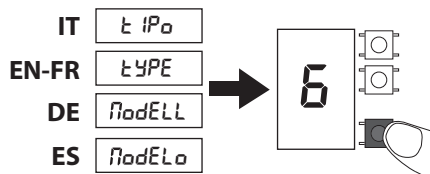

**White** Bianco - Blanc - Weiß - Blanco - Wit - Brancov - Λευκή - biały - белый - bílá - Ak - Bijela - Alb - أبيض  
**Red** Rosso - Roug - Rot - Rojo - Rood - Vermelho - κόκκινο - czerwony - красный - červený - kırmızı - Crvena - Roşu - أحمر  
**Black** Nero - Noir - Nero - Negro - Zwart - Preto - μαύρο - czarny - черный - černý - siyah - Crno - Negro - أسود

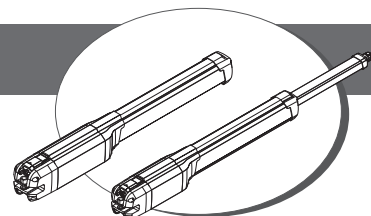
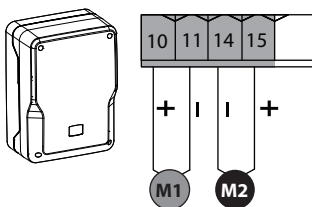

**PHOBOS BT A - PHOBOS BT B  
KUSTOS BT A - KUSTOS BT B**

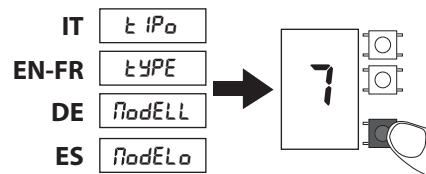

**PHOBOS VELOCE BT B35**

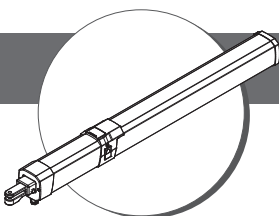
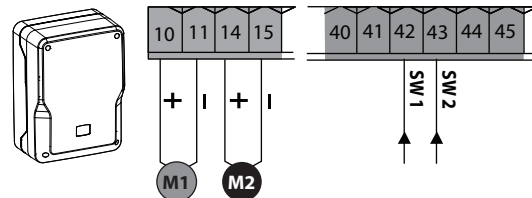
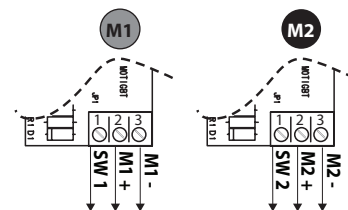
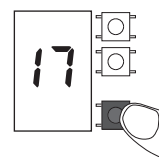

**GIUNO ULTRA**

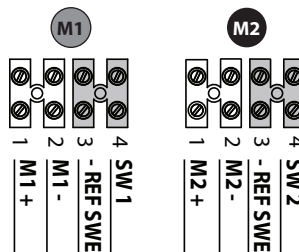
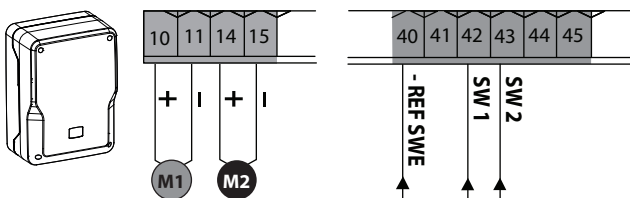
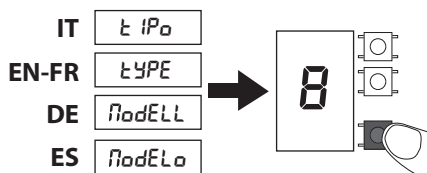

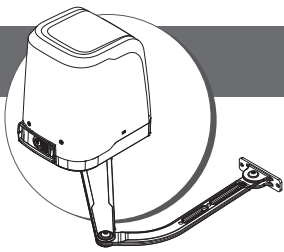

**VIRGO SMART BT A SLAVE**

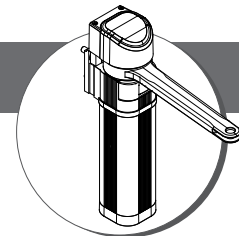
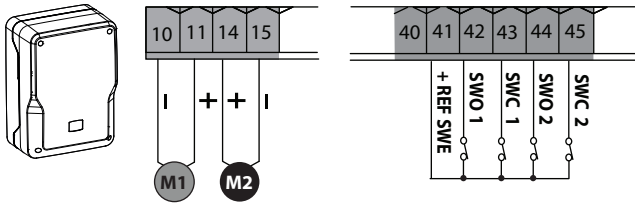
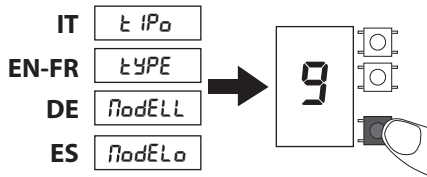

**E5 BT A 18**

**E5 BT A 12**

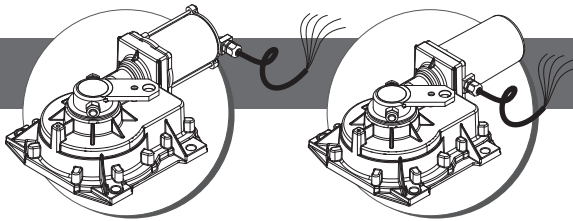
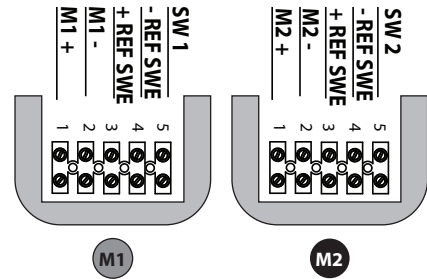
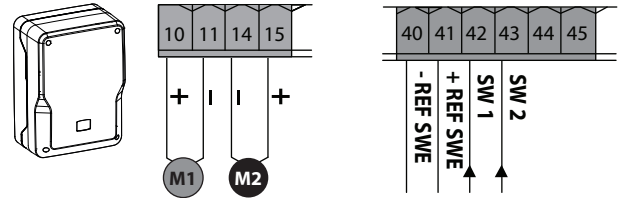
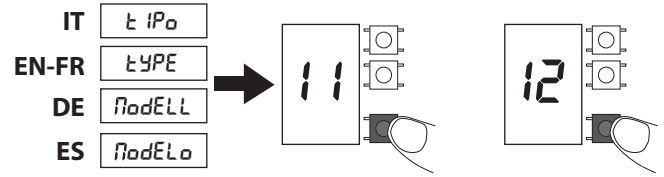

**ELI BT A40**

**ELI BT A35V**

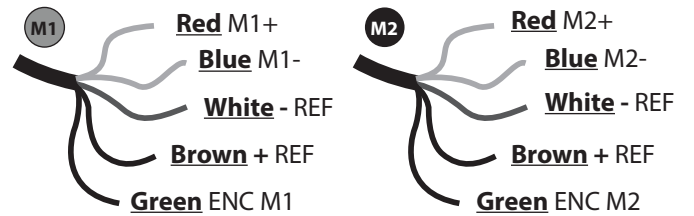
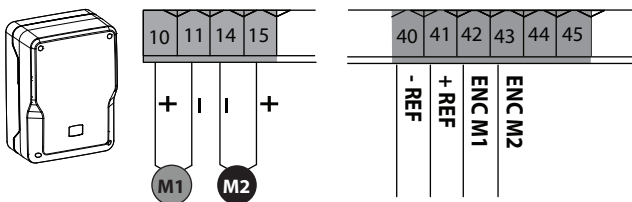
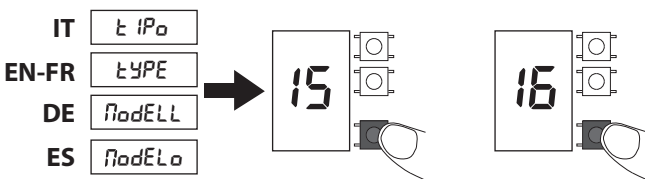

**Red:** Rosso - Roug - Rot - Rojo - Rood - Vermelho - κόκκινο - czerwony - красный - červený - kırmızı - Crvena - Roşu - أحمر

**Bleu:** Blu - Bleu - Blau Azul - Blauw - Azul Μπλε - niebieski - синий - mo-dro - mavi - Plava - alabastru - أزرق

**White:** Bianco - Blanc - Weiß - Blanco - Wit - Brancov - Λευκή - biały - белый - bílá - Ak - Bijela - Alb - أبيض

**Brown:** Marrone - Marron Braun - Maron - bruin - Castanho - καφέ - brązowy - коричневый - hnědý - kahverengi - Smeđa - Marro - بني

**Green:** Verde - Vert - Grün Verde - Groen - Verde Πράσινη - Gre-enЗеленый - Zelená - Yeşil - Zelena - Verde - أخضر

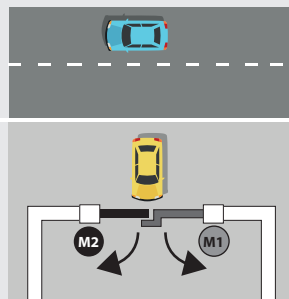

<https://www.bft-automation.com/qrcodemanual/D814283>

COME PROGRAMMARE LA SCHEDA - HOW TO PROGRAM THE BOARD  
 COMMENT PROGRAMMER LA CARTE - PROGRAMMIERUNG DER REGISTERKARTE  
 CÓMO PROGRAMAR LA TARJETA - HOE DE KAART TE PROGRAMMEREN  
 COMO PROGRAMAR A PLACA - ΤΡΟΠΟΣ ΠΡΟΓΡΑΜΜΑΤΙΣΜΟΥ ΤΗΣ ΠΛΑΚΕΤΑΣ  
 JAK ZAPROGRAMOWAĆ KARTĘ - ПРОГРАММИРОВАНИЕ ПЛАТЫ  
 JAK NAPROGRAMOVAT KARTU - KARTIN NASIL PROGRAMLANACAĞI  
 KAKO PROGRAMIRATI PLOČU - CUM SE PROGRAMEAZĂ PLACA DE CIRCUITE -  
 كيفية برمجة المجلس

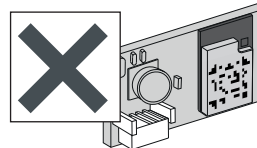
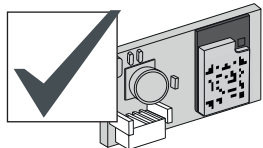

1

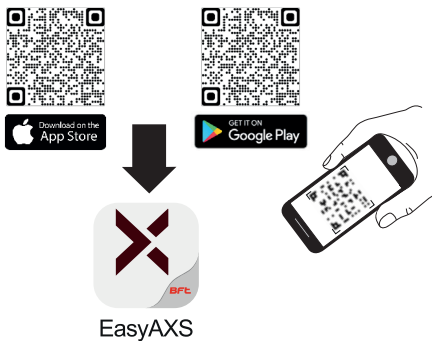

2

(IT) Programmo il quadro con APP  
 (EN) Programming the panel with APP  
 (FR) Programmation du panneau avec APP  
 (DE) Programmierung des Panels über die APP  
 (ES) Programación del cuadro con APP  
 (NL) Ik programmeer het paneel met de APP  
 (PT) Programação do painel com APP  
 (EL) Προγραμματίζω το πλαίσιο με την APP  
 (PL) Programowanie centrali za pomocą aplikacji  
 (RU) Программирование пульта с приложением  
 (CS) Programování panelu pomocí aplikace  
 (TR) Çerçeveyi APP ile programlıyorum  
 (HR) Programiranje ploče pomoću aplikacije  
 (RO) Program cu panou cu aplicație  
 (AR) برمجة اللوحة باستخدام التطبيق

(IT) Programmo quadro da display  
 (EN) Programming the panel from the display  
 (FR) Programmation du panneau à partir de l'écran  
 (DE) Programmierung des Panels über das Display  
 (ES) Programación del cuadro desde la pantalla  
 (NL) Ik programmeer het paneel via het display  
 (PT) Programação do painel a partir do ecrã  
 (EL) Προγραμματίζω τον πίνακα από την οθόνη  
 (PL) Programowanie centrali z poziomu wyświetlacza  
 (RU) Программирование пульта через дисплей  
 (CS) Programování panelu z displeje  
 (TR) Paneli ekrandan programlıyorum  
 (HR) Programiranje ploče preko zaslona  
 (RO) Program cu panou cu ecran  
 (AR) برمجة اللوحة من الشاشة



AZIENDA CON  
 SISTEMA DI GESTIONE  
 CERTIFICATO DA DNV GL  
 = ISO 9001 =  
 = ISO 14001 =



U-Security



24 V



8 027908 796486 >

**BFT**  
[www.bft-automation.com](http://www.bft-automation.com)  
**BFT Spa**  
 Via Lago di Vico, 44 ITALY  
 36015 Schio (VI)  
 T +39 0445 69 65 11  
 F +39 0445 69 65 22

**SPAIN**  
**BFT GROUP ITALIBERICA DE AUTOMATISMOS SL**  
 Camí de Can Bassa, 6, 08401 Granollers, Barcelona, Spagna

**FRANCE**  
**AUTOMATISMES BFT FRANCE SAS**  
 50 rue Jean Zay  
 69800 Saint-Priest, Francia

**GERMANY**  
**BFT ANTRIEBSSYSTEME GMBH**  
 Faber-Castell-Straße 29, 90522 Oberasbach, Germania

**UNITED KINGDOM**  
**BFT AUTOMATION UK LTD**  
 Unit C2-C3 The Embankment Business Park, Vale Road Heaton Mersey Stockport Cheshire SK4 3GL United Kingdom

**BFT AUTOMATION (SOUTH) LTD**  
 Enterprise House Murdock Road, Dorcan, Swindon, England, SN3 5HY

**PORTUGAL**  
**BFT PORTUGAL SA**  
 Urb. Pedrulha lote 9 - Apartado 8123, 3025-248 Coimbra Portugal

**POLAND**  
**BFT POLSKA SP ZOO**  
 Marecka 49, 05-220 Zielonka, Polonia

**IRELAND**  
**BFT AUTOMATION IRELAND**  
 Unit D3 City Link Business Park, Old Naas Road, Dublin

**CROATIA**  
**BFT ADRIA DOO**  
 Obrovac 39, 51218, Dražice, Croazia

**CZECH REPUBLIC**  
**BFT CZ SRO**  
 Ustecka 533/9, 184 00 Praha 8, Czech

**TURKEY**  
**BFT OTOMASYON KAPI**  
 Şerifali Mahallesi, no, 34775 Ümraniye/Istanbul, Turchia

**U.S.A.**  
**BFT AMERICAS INC.**  
 1200 S.W. 35th Avenue Suite B Boynton Beach FL 33426

**AUSTRALIA**  
**BFT AUTOMATION AUSTRALIA PTY**  
 29 Bentley St, Wetherill Park NSW 2164, Australia

**EMIRATES**  
**BFT MIDDLEEAST FZCO**  
 FZS2 AA01 - PO BOX 262200, Jebel Ali Free Zone South Zone 2, Dubai - United Arab

**NEW ZEALAND**  
**BFT AUTOMATION NEW ZEALAND**  
 224/A Bush Road, Rosedale, Auckland, New Zealand